

OVIA

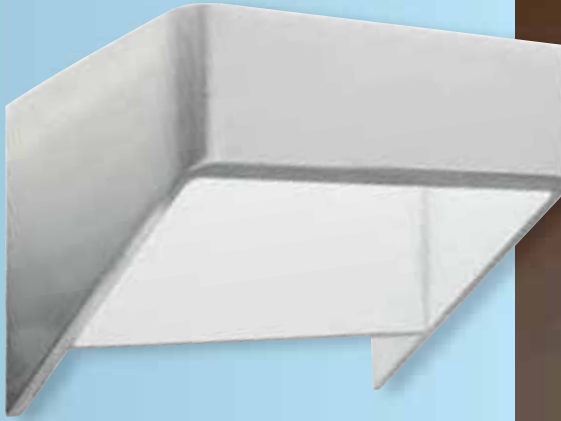

Low Energy LED Lighting



230V LED Wall Light

code

wattage

LED310WH*

4.5W Integrated LED

LED Colour Options

WH

Cool White

Available Finishes (*)

WH

White

AL

Aluminium

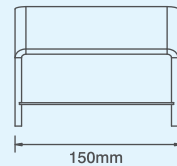
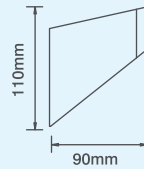

Product Approvals
Complies with BS EN 60598.

Please add required finish on to the code e.g. **LED310WHAL**.

LOW ENERGY LED LIGHTING - Surface Mounted LED Wall Light

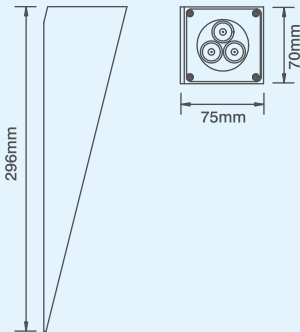

Product Approvals
Complies with BS EN 60598.

230V LED Chamfered Wall Light

code

wattage

LED315WH*

3W Integrated LED

LED Colour Options

WH

Warm White

Available Finishes (*)

WH

White

BK

Black

Please add required finish on to the code e.g. **LED315WHBK**.



230V LED Mini Up or Down Light

code

wattage

LED311AL

1W Integrated LED

Available Finishes

AL

Aluminium

LED Colour Options (*)

BL

Blue

WH

Cool White

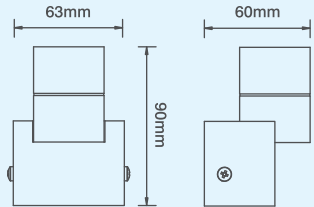

Product Approvals
Complies with BS EN 60598.

Please add required lamp option on to the code e.g. **LED311ALWH.**

LOW ENERGY LED LIGHTING - Surface Mounted LED Wall Light

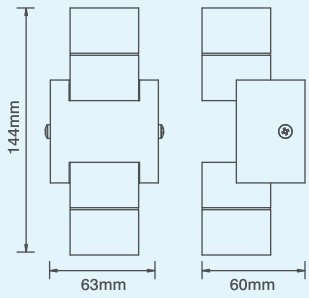

Product Approvals
Complies with BS EN 60598.

230V LED Mini Up & Down Light

code	wattage
LED312AL	2 x 1W Integrated LED

Available Finishes
AL Aluminium

LED Colour Options
BL Blue WH Cool White

Please add required lamp option on to the code e.g. **LED312ALWH**.

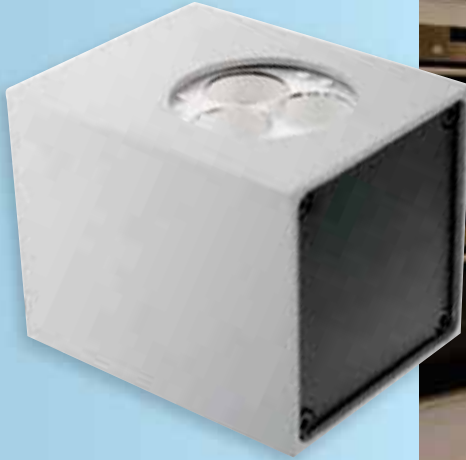

230V LED Cube Wall Light

code

wattage

LED313WH*

3W Integrated LED

LED Colour Options

WH

Warm White

Available Finishes (*)

WH

White

BK

Black

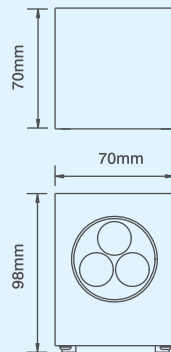

Product Approvals
Complies with BS EN 60598.

Please add required finish on to the code e.g. **LED313WHBK**.

LOW ENERGY LED LIGHTING - Surface Mounted LED Ceiling Light

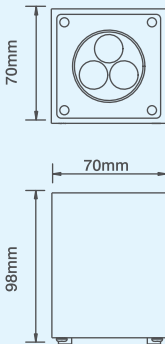

Product Approvals
Complies with BS EN 60598.

230V LED Cube Downlight

code

wattage

LED314WH*

3W Integrated LED

LED Colour Options

WH

Warm White

Available Finishes (*)

WH

White

BK

Black

Please add required finish on to the code e.g. **LED314WHBK**.



230V LED Up & Down Light

code

wallage

LED316WH*

2 x 1W Integrated LED

LED Colour Options

WH

Warm White

Available Finishes (*)

WH

White

BK

Black

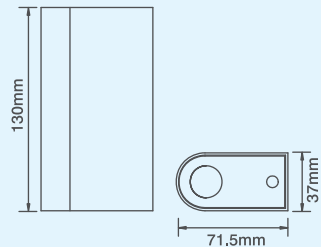

Product Approvals
Complies with BS EN 60598.

Please add required finish on to the code e.g. **LED316WHBK**.

LOW ENERGY LED LIGHTING - Surface Mounted LED Wall Light



IP44

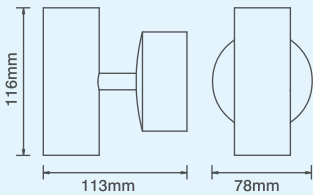

Product Approvals
Complies with BS EN 60598.

230V LED IP44 Up & Down Light

code

wattage

LED501*CH

2 x 1W Integrated LED

LED Colour Options (☛)



Blue



Cool White

Available Finishes



Chrome

Please add lamp option in to the code e.g. **LED501BLCH**.



230V LED Square Glass Wall Light

code

wallage

LED325*BS

1.5W Integrated LED

LED Colour Options (*)

BL

WH

Blue

Cool White

Available Finishes

BS

Brushed Stainless

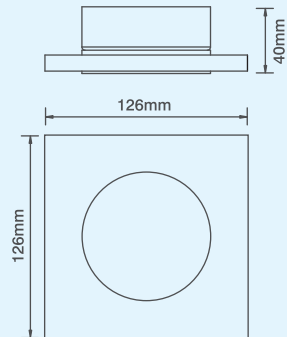

Product Approvals
Complies with BS EN 60598.

Please add lamp option in to the code e.g. **LED325WHBS.**

LOW ENERGY LED LIGHTING - Surface Mounted LED Wall Light

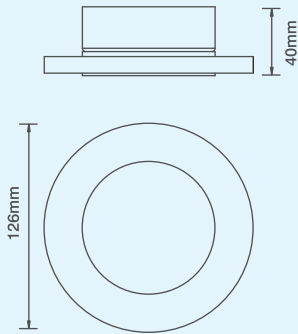



Product Approvals
Complies with BS EN 60598.

230V LED Round Glass Wall Light

code	wattage
LED326BS	1.5W Integrated LED

LED Colour Options (♦)

 BL	 WH
Blue	Cool White

Available Finishes

 BS
Brushed Stainless

Please add lamp option in to the code e.g. **LED326BLBS**.



230V IP54 Angled Aluminium Wall Light

code	no. of lamps	lampholder type	max wattage
LE601AL♦	1	GX53	9W

C/W Selected Lamp

CFLi options for LE601AL fitting are available on page b42

Available Finishes



Aluminium

LED Colour Options (†)



2.7W
Blue



3W
Cool White

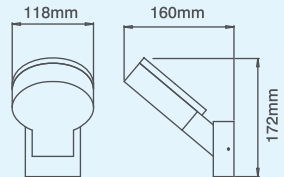

Product Approvals

Good protection against ingress of dust and moisture. Complies with BS EN 60598.

Please add lamp option on to the code e.g. **LE601ALLEDB.**

LOW ENERGY LED LIGHTING - Surface Mounted Angled Aluminium Wall Light

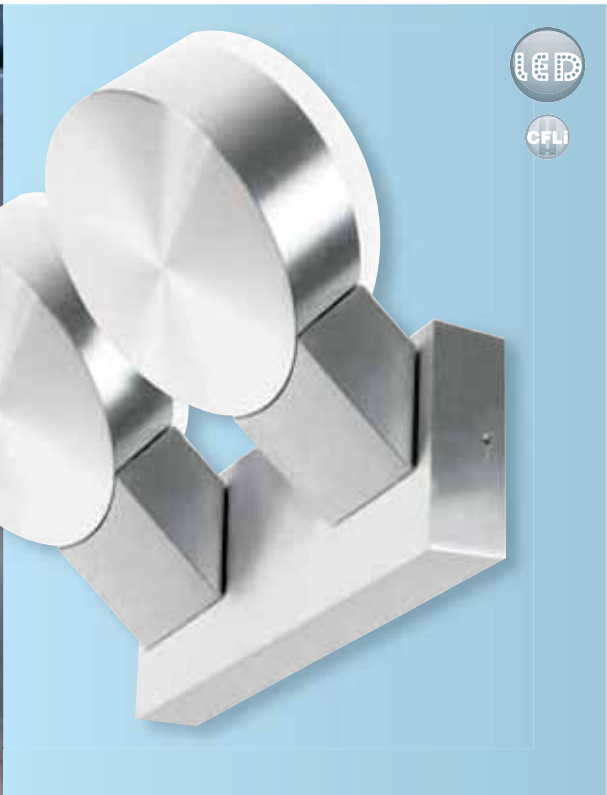

230V IP54 Angled Aluminium Wall Light

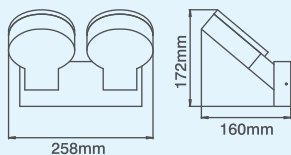

code	no. of lamps	lampholder type	max wattage
LE602AL↓	2	GX53	2 x 9W

C/W Selected Lamp

CFLi options for LE602AL fitting are available on page b43

Available Finishes



Aluminium

LED Colour Options (↓)



2.7W
Blue



3W
Cool White

Product Approvals

Good protection against ingress of dust and moisture.
Complies with BS EN 60598.

Please add lamp option on to the code e.g. **LE602ALLEDC**.



230V Low Energy IP44 Wall Light

code	no. of lamps	lampholder type	max wattage
LE611CH4SWL	1	E14	15W

Lamp Included

CFLi options for LE611CH fitting are available on page b44

Available Finishes



Chrome

LED Colour Options (†)



4W
SMD LED
Warm White

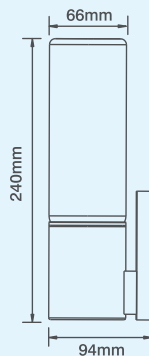

Product Approvals
Complies with BS EN 60598.

Please add lamp option on to the code e.g. **LE611CH4SWL**.

LOW ENERGY LED LIGHTING - Surface Mounted Wall Lights



IP44

230V Low Energy IP44 Wall Light

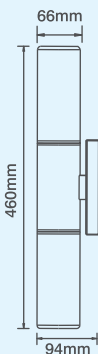

code	no. of lamps	lampholder type	max wattage
LE612CH4SWL	2	E14	2 x 15W

Lamp Included

CFLi options for LE612CH fitting are available on page b45

Available Finishes

CH

Chrome

LED Colour Options (♦)

4SWL

4W
SMD LED
Warm White

Product Approvals
Complies with BS EN 60598.

Please add lamp option on to the code e.g. **LE612CH4SWL**.



230V 'ORO' Surface Spotlight

code	no. of lamps	lampholder type	max wattage	tilt	rotation
GU120*◆	1	GU10	50W	100°	350°
C/W Selected Lamp					

Available Finishes (*)



Lamp Options (◆)

4SCL	4SWL	6SCL	6SWL
4W SMD LED Cool White	4W SMD LED Warm White	6W SMD LED Cool White	6W SMD LED Warm White

Dimmable Lamp Options (◆)

4SCD	4SWD
4.5W SMD LED Dim' Cool White	4.5W SMD LED Dim' Warm White

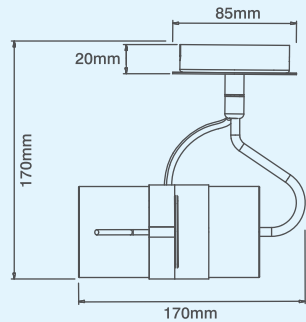

Product Approvals
Complies with BS EN 60598.

Please add required finish on to the code e.g. **GU120SV4SCL**.

LOW ENERGY LED LIGHTING - Surface Mounted
GIUSTO Surface Spotlight

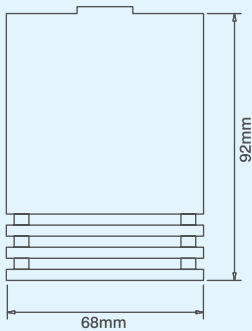

230V 'GIUSTO' Surface Spotlight

code	no. of lamps	lampholder type	max wattage
GU200SV♦	1	GU10	50W
C/W Selected Lamp			

Available Finishes

SV

Silver

Lamp Options (♦)

4SCL

4W

SMD LED
Cool White

4SWL

4W

SMD LED
Warm White

6SCL

6W

SMD LED
Cool White

6SWL

6W

SMD LED
Warm White

Dimmable Lamp Options (♦)

4SCD

4.5W

SMD LED Dim'
Cool White

4SWD

4.5W

SMD LED Dim'
Warm White

Product Approvals

Complies with BS EN 60598.

Please add required finish on to the code e.g. **GU200SV4SWD**.



230V 'OCCA' Surface Spotlight

code	no. of lamps	lampholder type	max wattage	tilt	rotation
GU110*◆	1	GU10	50W	100°	350°
C/W Selected Lamp					

Available Finishes (*)



Silver



Chrome



Satin Chrome

Lamp Options (◆)



4W
SMD LED
Cool White



4W
SMD LED
Warm White



6W
SMD LED
Cool White



6W
SMD LED
Warm White



4.5W
SMD LED Dim'
Cool White



4.5W
SMD LED Dim'
Warm White

Dimmable Lamp Options (◆)

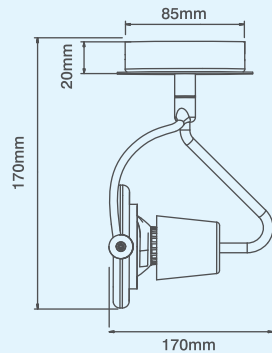

Product Approvals
 Complies with BS EN 60598.

Please add required finish on to the code e.g. **GU110SV4SCD**.

LOW ENERGY LED LIGHTING - Surface Mounted OCTA Surface Mounted Spotlight

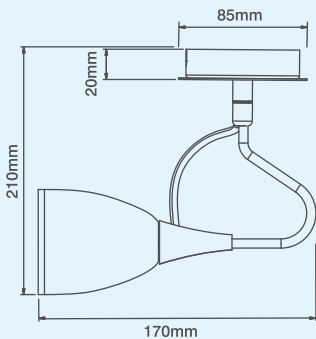

230V 'OCTA' Surface Spotlight

code	no. of lamps	lampholder type	max wattage	tilt	rotation
GU130♦	1	GU10	50W	100°	350°w
C/W Selected Lamp					

Available Finishes (*)



Silver



Chrome



Satin Chrome

Lamp Options ♦

4SCL

4W
SMD LED
Cool White

4SWL

4W
SMD LED
Warm White

6SCL

6W
SMD LED
Cool White

6SWL

6W
SMD LED
Warm White

Dimmable Lamp Options ♦

4SCD

4.5W
SMD LED Dim'
Cool White

4SWD

4.5W
SMD LED Dim'
Warm White

Product Approvals

Complies with BS EN 60598.

Please add required finish on to the code e.g. **GU130CH6SWL**.



Product Approvals
Complies with BS EN 60598.

230V LED Striplight

Mounting Positions



I = 32mm



code

wattage

LED301*WH

2.7W Integrated LED

Supply or link lead required. See Accessories listed below.
All our LED strip-lights can be connected end to end.

LED Colour Options (†)

Available Finishes



Blue



Cool White



White

230V LED Striplight

Mounting Positions



I = 32mm

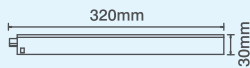

code

wattage

LED302*WH

3.6W Integrated LED

Supply or link lead required. See Accessories listed below.
All our LED strip-lights can be connected end to end.

LED Colour Options (†)

Available Finishes



Blue



Cool White



White

230V LED Striplight

Mounting Positions



I = 32mm



code

wattage

LED303*WH

6.8W Integrated LED

Supply or link lead required. See Accessories listed below.
All our LED strip-lights can be connected end to end.

LED Colour Options (†)

Available Finishes



Blue



Cool White



White

Accessories

code

description

LED305WH

230V 1M LED Striplight Supply Lead

LED307WH

230V 0.25M LED Striplight Link Lead

LED308WH

230V 0.5M LED Striplight Link Lead

Please add lamp option in to the code e.g. **LED303BLWH**.



230V Long Pendant Fitting

code	no. of lamps	lampholder type	max wattage
PSO05AL♦	1	ES27	60W
C/W Selected Lamp			

Available Finishes

AL

Aluminium

Lamp Options (♦)

11AWL

11W
SMD LED
Warm White

Dimmable Lamp Options (♦)

7AWD

7.5W
SMD LED Dim'
Warm White

12AWD

12W
SMD LED Dim'
Warm White

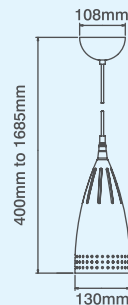

Product Approvals
Complies with BS EN 60598.

Please add required finish on to the code e.g. **PSO05AL11AWL**.

LOW ENERGY LED LIGHTING - Surface Mounted Spun Aluminium Pendant Fittings

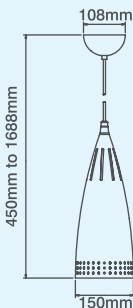

230V Long Pendant Fitting

code	no. of lamps	lampholder type	max wattage
PS010AL♦	1	ES27	60W
C/W Selected Lamp			

Available Finishes



Aluminium

Lamp Options ♦



11W
SMD LED
Warm White

Dimmable Lamp Options ♦



7.5W
SMD LED Dim'
Warm White



12W
SMD LED Dim'
Warm White

Product Approvals
Complies with BS EN 60598.



Please add required finish on to the code e.g. **PS010AL7AWD**.



230V Dome Pendant Fitting

code	no. of lamps	lampholder type	max wattage
PS015AL♦	1	ES	60W
C/W Selected Lamp			

Available Finishes

AL

Aluminium

Lamp Options (♦)

11AWL

11W
SMD LED
Warm White

Dimmable Lamp Options (♦)

7AWD

7.5W
SMD LED Dim*
Warm White

12AWD

12W
SMD LED Dim*
Warm White

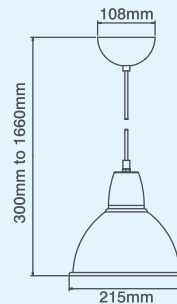

Product Approvals
Complies with BS EN 60598.

Please add required finish on to the code e.g. **PS015AL11AWL.**

LOW ENERGY LED LIGHTING - Surface Mounted Spun Aluminium Pendant Fittings

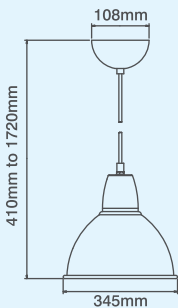

230V Dome Pendant Fitting

code	no. of lamps	lampholder type	max wattage
PS020AL♦	1	ES	60W
C/W Selected Lamp			

Available Finishes



Aluminium

Lamp Options ♦



11W
SMD LED
Warm White

Dimmable Lamp Options ♦



7.5W
SMD LED Dim'
Warm White



12W
SMD LED Dim'
Warm White

Product Approvals
Complies with BS EN 60598.



Please add required finish on to the code e.g. **PS020AL7AWD**.



230V Contour Pendant Fitting Enclosed with Clear Glass

code	no. of lamps	lampholder type	max wattage
PS025AL♦	1	ES	60W
C/W Selected Lamp			

Available Finishes

AL

Aluminium

Lamp Options (♦)

11AWL

11W
SMD LED
Warm White

Dimmable Lamp Options (♦)

7AWD

7.5W
SMD LED Dim*
Warm White

12AWD

12W
SMD LED Dim*
Warm White

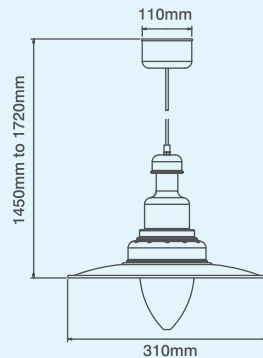

Product Approvals
Complies with BS EN 60598.

Please add required finish on to the code e.g. **PS025AL11AWL**.

LOW ENERGY LED LIGHTING - Surface Mounted Spun Aluminium Pendant Fittings

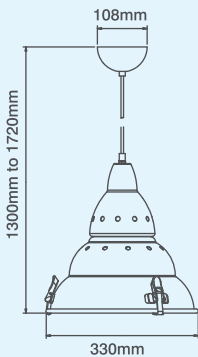

230V Clamped Pendant Fitting Enclosed with Frosted Glass

code	no. of lamps	lampholder type	max wattage
PS030AL	1	ES	60W

C/W Selected Lamp

Available Finishes

AL

Aluminium

Lamp Options (♦)

11AWL

11W
SMD LED
Warm White

Dimmable Lamp Options (♦)

7AWD

7.5W
SMD LED Dim'
Warm White

12AWD

12W
SMD LED Dim'
Warm White

Product Approvals
Complies with BS EN 60598.



Please add required finish on to the code e.g. **PS030AL7AWD**.



Modular LED stairlight fitted into a Click Define New Media plate

230V Modular LED Stairlight

code

wattage

MM1000

1W Integrated LED

A versatile 50mm x 50mm Euro module LED, which clips into a '311' or '312' New Media plate. Utilises a standard wiring accessory back box.

Please see opposite page and the dedicated Click Wiring Accessories catalogue for more information on New Media plates and back boxes.

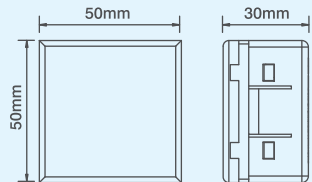

LED Colour Options (†)



Blue

Cool White

Warm White

Product Approvals
Complies with BS EN 60598.

Please add lamp option on to the code e.g. **MM1000BL**.

LOW ENERGY LED LIGHTING - Flush Mounted

New Media Plates



Deco plates are manufactured from stainless steel, available in the following finishes: Antique Brass (AB), Polished Brass (BR), Satin Brass (SB), Polished Chrome (CH), Satin Chrome (SC), Black Nickel (BN), Pearl Nickel (PN) and Stainless Steel (SS). Georgian Style (GCBF) plates are manufactured from cast brass. Please note: Antique Brass and Black Nickel are only available with black inserts. Understanding the code: VP - Plate Style BN - Plate Finish 011 - Product No. BK - Insert Colour

Every DEFINE product featured is available in 5 distinctive quality finishes: Polished Chrome, Stainless Steel, Brushed Steel*, Pearl Nickel and Black Nickel. *UK Design Registration 3015621

Definity plates are coated stainless steel, available in the following finishes: Brushed Steel (BS), Polished Chrome (CH) and Stainless Steel (SS). White (PW) is also available, produced from polycarbonate. Understanding the code: SIN - Insert Prefix 036 - Product No BK - Insert Colour SS - 'INGOT' Switch Finish (if applicable). SCP - Definity Cover Plate Prefix 436 - Product No SS - Plate Colour.

New Media Unfurnished Plates

code	description
VP*311	Deco 1 Gang Plate Twin Aperture (Unfurnished)
VP*312	Deco 2 Gang Plate Quad Aperture (Unfurnished)
FP*311	Define 1 Gang Plate Twin Aperture (Unfurnished)
FP*312	Define 2 Gang Plate Quad Aperture (Unfurnished)
SIN311BK	Definity 1 Gang Insert Twin Aperture (Unfurnished)
SCP311*	Definity 1 Gang Cover Twin Aperture (Unfurnished)
SIN312BK	Definity 2 Gang Insert Quad Aperture (Unfurnished)
SCP312*	Definity 2 Gang Cover Quad Aperture (Unfurnished)
CMA311	Mode 1 Gang Plate Twin Aperture (Unfurnished)
CMA312	Mode 2 Gang Plate Quad Aperture (Unfurnished)
PRW311	Polar 1 Gang Plate Twin Aperture (Unfurnished)
PRW312	Polar 2 Gang Plate Quad Aperture (Unfurnished)
CMA311AG	Part-M 1 Gang Plate Twin Aperture (Unfurnished)
CMA312AG	Part-M 2 Gang Plate Quad Aperture (Unfurnished)



230V Square Recessed Downlighter

code	no. of lamps	lampholder type	max wattage
GZ105♦	1	GZ10/GU10	50W

C/W Selected Lamp

NOTE: Features a housed terminal block with loop-in and loop-out facility.

Available Finishes (*)

WH	CH	SC
White	Chrome	Satin Chrome

Lamp Options (†)

4SCL	4SWL	6SCL	6SWL	4SCD	4SWD
4W	4W	6W	6W	4.5W	4.5W
SMD LED	SMD LED	SMD LED	SMD LED	SMD LED Dim'	SMD LED Dim'
Cool White	Warm White	Cool White	Warm White	Cool White	Warm White

Dimmable Lamp Options (†)

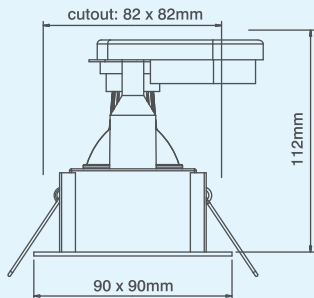

Product Approvals
Complies with BS EN 60598.

Please add required finish on to the code e.g. **GZ105SC6SWL**.

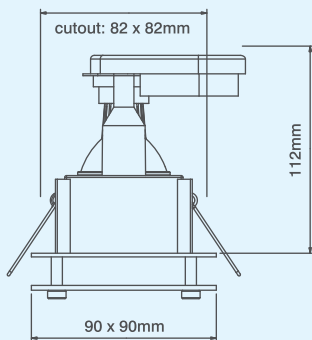

Product Approvals

Complies with BS EN 60598.

230V Square Recessed Downlighter with Drop Glass

code	no. of lamps	lampholder type	max wattage
GZ107*♦	1	GZ10/GU10	50W
C/W Selected Lamp			

NOTE: Features a housed terminal block with loop-in and loop-out facility.

Available Finishes (*)

 WH White	 CH Chrome	 SC Satin Chrome
-----------------	------------------	------------------------

Lamp Options (♦)

 4SCL 4W SMD LED Cool White	 4SWL 4W SMD LED Warm White	 6SCL 6W SMD LED Cool White	 6SWL 6W SMD LED Warm White	 4SCD 4.5W SMD LED Dim' Cool White	 4SWD 4.5W SMD LED Dim' Warm White
---	---	---	---	--	--

Dimmable Lamp Options (♦)

Please add required finish on to the code e.g. **GZ107CH4SWD**.



230V Cast Eyeball Downlighter

code	no. of lamps	lampholder type	max wattage	tilt	rotation
GZ520*◆	1	GZ10/GU10	50W	20°	355°

C/W Selected Lamp

Available Finishes (*)



Lamp Options (◆)

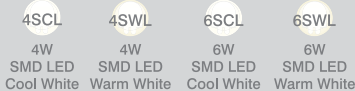

Dimmable Lamp Options (◆)

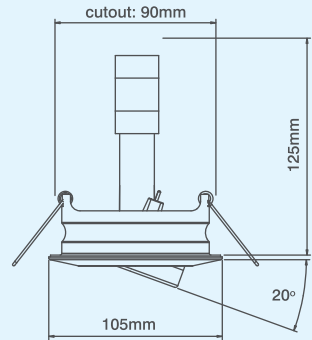

Product Approvals
Complies with BS EN 60598.

Please add required finish on to the code e.g. **GZ520CH4SCL**.

LOW ENERGY LED LIGHTING - Flush Mounted Professional Square Wallwash



Adjustable to any angle from down light to 30° wallwash

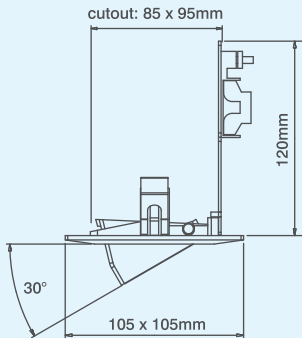

Product Approvals
Complies with BS EN 60598.

230V Cast Square Wallwash Downlighter

code	no. of lamps	lampholder type	max wattage	tilt	rotation
GZ540♦	1	GZ10/GU10	50W	30°	N/A
C/W Selected Lamp					

Available Finishes (*)



Lamp Options (♦)

4SCL 4W SMD LED Cool White	4SWL 4W SMD LED Warm White	6SCL 6W SMD LED Cool White	6SWL 6W SMD LED Warm White
-------------------------------------	-------------------------------------	-------------------------------------	-------------------------------------

Dimmable Lamp Options (♦)

4SCD 4.5W SMD LED Dim' Cool White	4SWD 4.5W SMD LED Dim' Warm White
--	--

Please add required finish on to the code e.g. **GZ540AB4SWL**.



230V Cast Recessed Downlighter

code	no. of lamps	lampholder type	max wattage
GZ560*♦	1	GZ10/GU10	50W

C/W Selected Lamp

Available Finishes (*)



Lamp Options (♦)

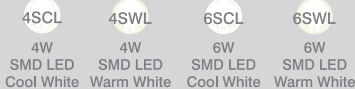

Dimmable Lamp Options (♦)

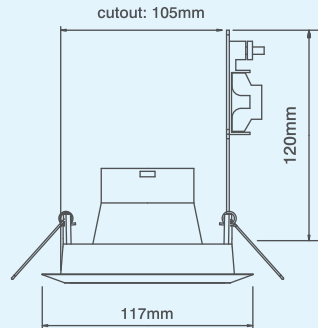

Product Approvals
Complies with BS EN 60598.

Please add required finish on to the code e.g. **GZ560CH6SWL**.

LOW ENERGY LED LIGHTING - Surface Mounted

Low Energy Undercupboard Light

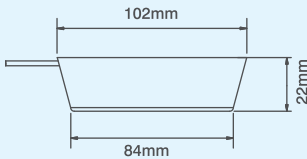

240V Low Energy Undercupboard Lights

code	no. of lamps	lampholder type	max wattage
LE105*3SCL	1	GX53	13W
Lamp Included			

Available Finishes (*)



White



Chrome



Satin Chrome

Lamp Options

3SCL

3W
SMD LED
Cool White

Product Approvals
Complies with BS EN 60598.



Please add required finish on to the code e.g. **LE105CH3SCL**.



230V Fixed Compact Downlighter - protruding lamp

code	no. of lamps	lampholder type	max wattage		
LE015*3SCL	1	GX53	13W		
code	description	dimensions	cutout (mm)	supply (mm)	max wattage
CG015	In-Line Maintained Em/Pack	45 x 38 x 860	60	230	15

Available Finishes (*)



White



Chrome



Satin Chrome

Lamp Options

3SCL

3W
SMD LED
Cool White

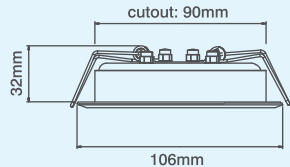

Product Approvals
Complies with BS EN 60598.

Please add required finish on to the code e.g. **LE015SC3SCL**.

LOW ENERGY LED LIGHTING - Flush Mounted Compact Downlighter

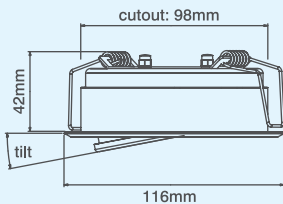

230V Adjustable Compact Downlighter - protruding lamp

code	no. of lamps	lampholder type	max wattage	tilt	
LE020*3SCL	1	GX53	13W	10°	
code	description	dimensions	cutout (mm)	supply (mm)	max wattage
CG015	In-Line Maintained Em/Pack	45 x 38 x 860	60	230	15

Available Finishes (*)



White



Chrome



Satin Chrome

Lamp Options

3SCL

3W
SMD LED
Cool White

Product Approvals
Complies with BS EN 60598.



Please add required finish on to the code e.g. **LE020CH3SCL**.



230V Fixed Compact Downlighter - Flush Lamp

code	no. of lamps	lampholder type	max wattage		
LE035*3SCL	1	GX53	13W		
code	description	dimensions	cutout (mm)	supply (mm)	max wattage
CG015	In-Line Maintained Em/Pack	45 x 38 x 860	60	230	15

Available Finishes (*)



Lamp Options (♦)

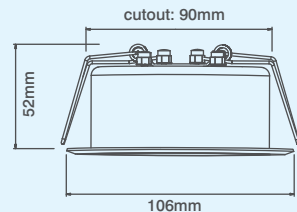

Product Approvals
Complies with BS EN 60598.

Please add required finish on to the code e.g. **LE035SC3SCL**.

LOW ENERGY LED LIGHTING - Flush Mounted Compact Downlighter

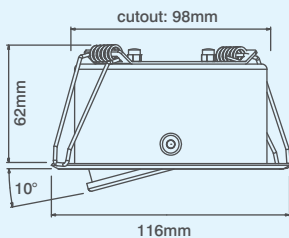

230V Adjustable Compact Downlighter - Flush Lamp

code	no. of lamps	lampholder type	max wattage	tilt	
LE040*3SCL	1	GX53	13W	10°	
code	description	dimensions	cutout (mm)	supply (mm)	max wattage
CG015	In-Line Maintained Em/Pack	45 x 38 x 860	60	230	15

Available Finishes (*)

WH

White

CH

Chrome

SC

Satin Chrome

Lamp Options

3SCL

3W
SMD LED
Cool White

Product Approvals
Complies with BS EN 60598.



Please add required finish on to the code e.g. **LE040CH3SCL**

A large area of horizontal light blue lines for writing notes, spanning most of the page width and height.